



Automation for a Changing World

Standard Compact Drive MS300 Series



www.deltaww.com

 **DELTA**
Smarter. Greener. Together.

Compact and Intelligent

The new standard for micro drives

The automation industry today continues to face challenges such as increasing competition and rising costs. In addition to improving productivity and reducing labor, the driving force for automation is the shift to higher efficiency, optimal quality, and most importantly, flexibility and compatibility for a wide range of applications.

Delta's MS300 series are the new generation high performance and standard compact vector control drives that inherit Delta's superior drive technology—all in a compact drive that has been reduced 40% in size.

A variety of essential functions are built-in as standard, including: PLC capacity for simple programming needs, a communication slots for various communication cards, and a USB port to make data uploads and downloads fast and easy. This saves the need for additional hardware, while providing more installation space for the power cabinet. Other key features include: Support for both IM and PM motor control for application flexibility, an STO function to ensure worry-free operation while protecting facilities from damage, and a simplified wiring process with a new screwless wiring design of terminal blocks for quick installation.

Saving space, reducing setup and wiring time, and providing high efficiency and a highly stable system, the MS300 are your key to improving market competitiveness and ensuring success.





Models Overview

- Standard Models
- High Speed Models
- Exterior Design and Interfaces
- Optional Cards

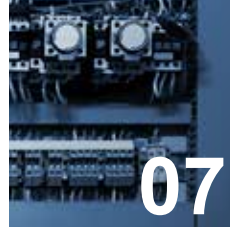

Optimized Space Utilization

- Compact Design
- Side-by-Side Installation



Outstanding Drive Performance

- Supports IM and PM Motors
- High Starting Torque
- Deceleration Energy Backup (DEB)
- Enhanced Braking Capability



Strong System Support

- Multi-motor Control
- Pulse Control
- Built-in PLC
- High Speed Applications
- 24 V_{DC} External Power
- High Overload Capability
- Built-in Brake Chopper
- Versatile Communications



Stable, Safe and Reliable

- Safety Standards
- Enhanced Conformal Coating
- IP40 Models
- Built-in EMC Filter



Easy to Install

- Application Groups
- Built-in USB Port
- Screwless Wiring of Control Terminal

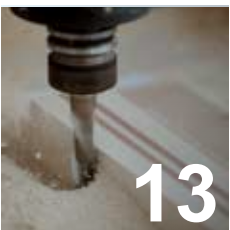

Wide Range of Applications

- Machine Tools
- Woodworking Machines
- Automatic Tool Changers (ATC)
- Pumps
- Packaging Machines
- Textile Machines



Specifications

- Product Specifications
- Wiring
- Dimensions
- Accessories
- Model Name Explanation
- Ordering Information

Models Overview



Standard Models

115V single-phase

Applicable Motor Output (kW)	0.2	0.4	0.75
Applicable Motor Output (HP)	0.25	0.5	1
Frame Size	A		C

230V single-phase

Applicable Motor Output (kW)	0.2	0.4	0.75	1.5	2.2
Applicable Motor Output (HP)	0.25	0.5	1	2	3
Frame Size	A		B	C	

230V single-phase (Built-in EMC filter)

Applicable Motor Output (kW)	0.2	0.4	0.75	1.5	2.2
Applicable Motor Output (HP)	0.25	0.5	1	2	3
Frame Size	B			C	

230V 3-phase

Applicable Motor Output (kW)	0.2	0.4	0.75	1.5	2.2	3.7/4	5.5	7.5	11	15
Applicable Motor Output (HP)	0.25	0.5	1	2	3	5	7.5	10	15	20
Frame Size	A			B	C		D	E		F

460V 3-phase

Applicable Motor Output (kW)	0.4	0.75	1.5	2.2	3.7/4	5.5	7.5	11	15	18.5	22
Applicable Motor Output (HP)	0.5	1	2	3	5	7.5	10	15	20	25	30
Frame Size	A		B	C		D		E		F	

460V 3-phase (Built-in EMC filter)

Applicable Motor Output (kW)	0.4	0.75	1.5	2.2	3.7/4	5.5	7.5	11	15	18.5	22
Applicable Motor Output (HP)	0.5	1	2	3	5	7.5	10	15	20	25	30
Frame Size	B			C		D		E		F	

High Speed Models



230V single-phase

Applicable Motor Output (kW)	1.5	2.2
Applicable Motor Output (HP)	2	3
Frame Size	C	

230V single-phase (Built-in EMC filter)

Applicable Motor Output (kW)	1.5	2.2
Applicable Motor Output (HP)	2	3
Frame Size	C	

230V 3-phase

Applicable Motor Output (kW)	1.5	2.2	3.7/4	5.5	7.5	11	15
Applicable Motor Output (HP)	2	3	5	7.5	10	15	20
Frame Size	B	C		D	E		F

460V 3-phase

Applicable Motor Output (kW)	1.5	2.2	3.7/4	5.5	7.5	11	15	18.5	22
Applicable Motor Output (HP)	2	3	5	7.5	10	15	20	25	30
Frame Size	B	C		D		E		F	

460V 3-phase (Built-in EMC filter)

Applicable Motor Output (kW)	1.5	2.2	3.7/4	5.5	7.5	11	15	18.5	22
Applicable Motor Output (HP)	2	3	5	7.5	10	15	20	25	30
Frame Size	B	C		D		E		F	

Hardware Design

Compact design and user-friendly interface

Removable Keypad

Press to remove; for remote operation away from drive



5 digits 7 segments LED display, frequency knob, Up and Left/Down function keys

Removable RFI Jumper

Applicable for different application needs



Built-in USB Port

Easy and fast programming setting, update and real-time monitoring and tuning



Specified Product Label

Input/output current, voltage and protection rating

Screwless Top Cover Design

Press on both side tabs to remove the cover



Removable Fan

Easy to replace and maintain for a longer lifetime



Option Cards

A wide selection of option cards for highly flexible applications



External Power Supply Card (DC 24V)



Communication Cards

CANopen



DeviceNet



PROFIBUS DP



EtherNet/IP



MODBUS TCP



EtherCAT*



*To be announced
(Please contact Delta Electronics, Inc. for release date)

Built-in I/O slot *1



Optimized Space Utilization

Compact Design

Provides more powerful features in smaller sizes with reduction up to 40% that effectively optimizes the installation space.



Side-by-Side Installation

Supports side-by-side installation with operating temperatures of $-20^{\circ}\text{C} \sim 40^{\circ}\text{C}$. Enables highly flexible and highly efficient installation.

Substantial savings in space!



Outstanding Drive Performance



Supports IM and PM Motors

Supports 4 independent induction motor control parameter sets.

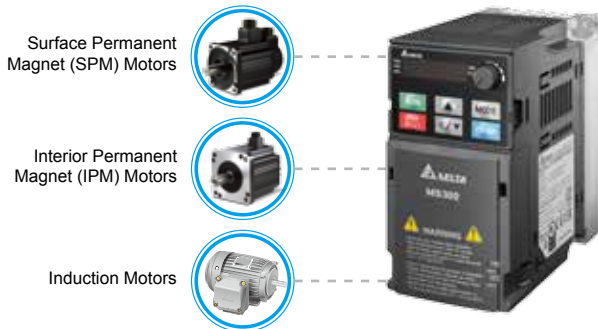

High Starting Torque

Delivers 200% high starting torque with a low speed control of 0.5Hz. This feature provides outstanding machine stability and is suitable for dynamic loading applications.

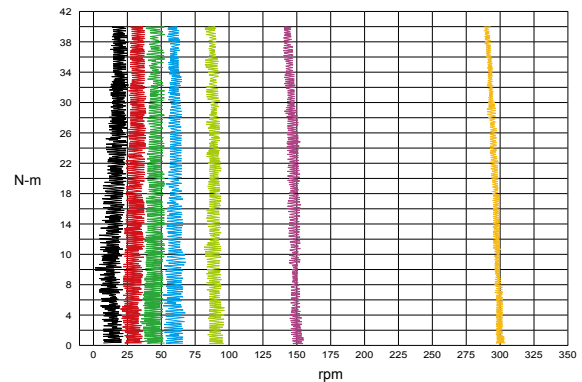

Deceleration Energy Backup (DEB)

Controls the motor deceleration to a stop when an unexpected power shut-down occurs to prevent mechanical damage. When power resumes, the motor will accelerate to its previous speed.

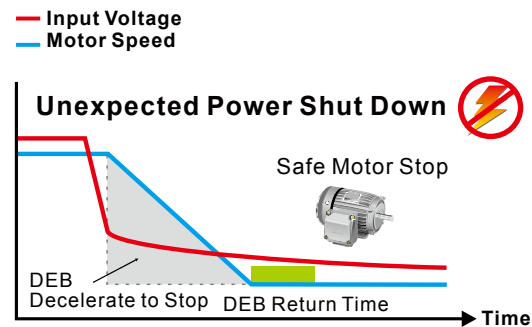
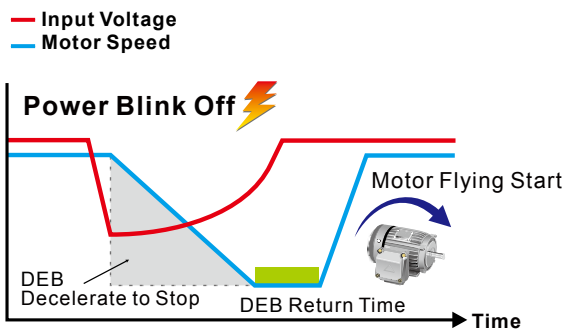

Enhanced Braking Capability

Provides Deceleration Energy Control Mode to shorten braking time by adjusting the motor speed and current. This feature replaces the need for braking resistors.

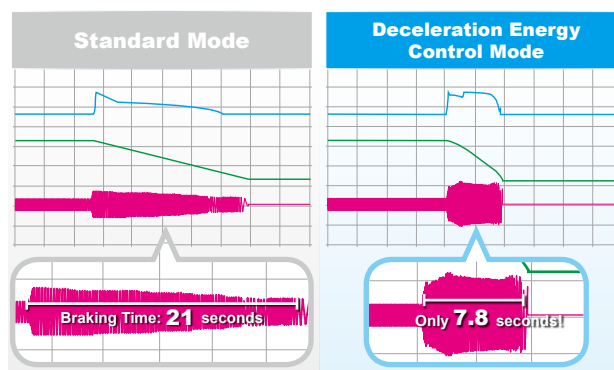

* Actual deceleration performance varies upon different system loads

Strong System Support

Multi-motor Control

Supports 4 induction motors switching control.

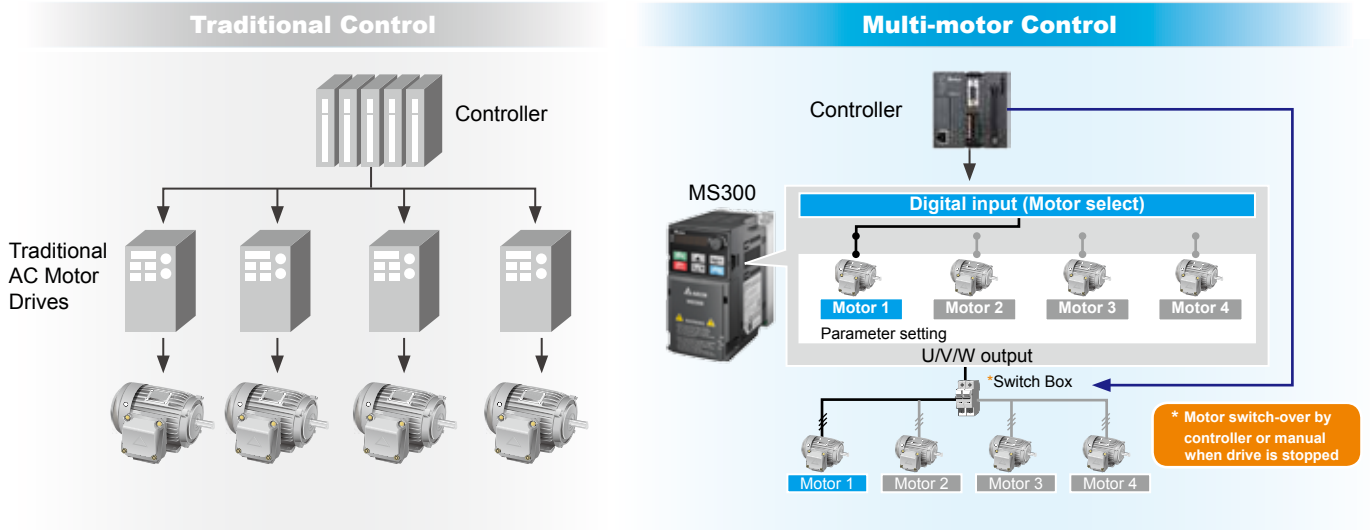

Pulse Input

Supports single pulse input signal from controller as frequency command.

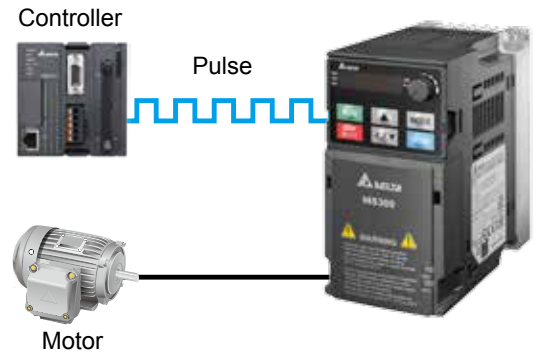

Built-in PLC

Built-in PLC capacity (2k steps) to provide distributed control and independent operation via network connection.

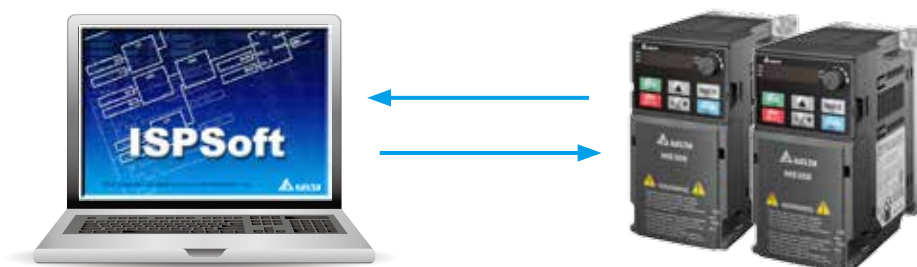

High-Speed Applications

High-speed models are available to support high-speed processing.

Type	Model	Frequency Setting
Standard	VFD□□□MS□□□□SAA	0 ~ 599Hz
High-speed	VFD□□□MS□□□□SHA	0 ~ 1500Hz

DC 24V External Power

External power supply card is available for external power connection. It protects the system and ensures uninterrupted communication when mains power failure occurs.

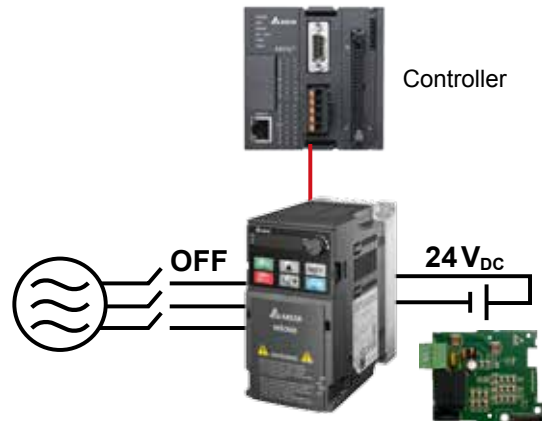

High Overload Capability

- Normal duty: rated current 120% for 60 seconds; 150% for 3 seconds
- Heavy duty: rated current 150% for 60 seconds; 200% for 3 seconds

Built-in Braking Chopper

Larger braking torque capability is provided by using an additional braking resistor.

Versatile Communication Interfaces

Built-in RS-485 (MODBUS) and various communication card options.

Communication	MS300
MODBUS	Built-in
PROFIBUS DP	Optional
DeviceNet	Optional
MODBUS TCP	Optional
EtherNet/IP	Optional
CANopen	Optional
EtherCAT	(To be announced)

Stable, Safe and Reliable



Safety Standard

Integrated Safe Torque Off (STO), compliance with:

- ▶ ISO 13849-1:2015 Category 3 PL d
- ▶ EN 60204-1 Category 0
- ▶ EN 61508 SIL2
- ▶ EN 62061 SIL CL 2

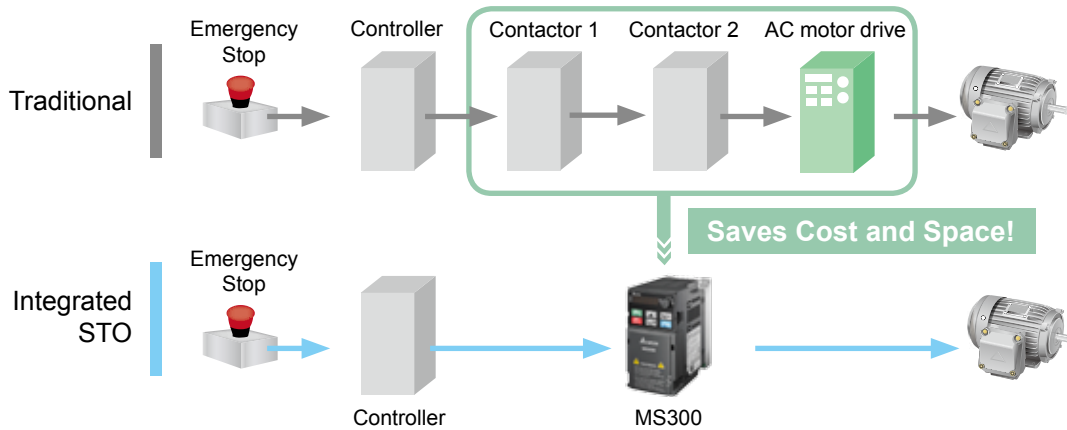

PCB Coating

100% PCB coating (IEC 60721-3-3 class 3C2 standard) ensures drive operation stability and safety in critical environments.

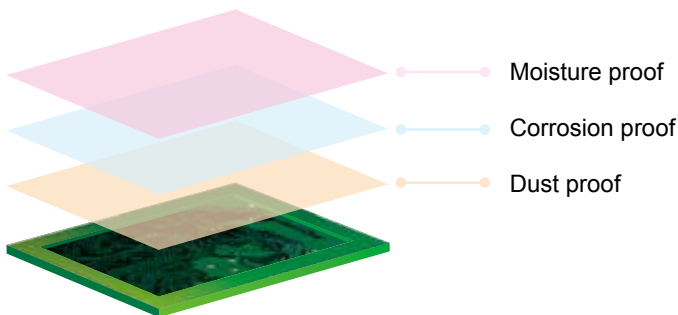

IP40 Models

Strengthened fan coating and concealed air vent prevent dust and other particles from entering the drive, suitable for critical environment applications.



Built-in EMC Filter

Built-in Class A (C2) standard EMC filter; saves on additional procurement cost and wiring time, and provides more cabinet space for other devices to use.

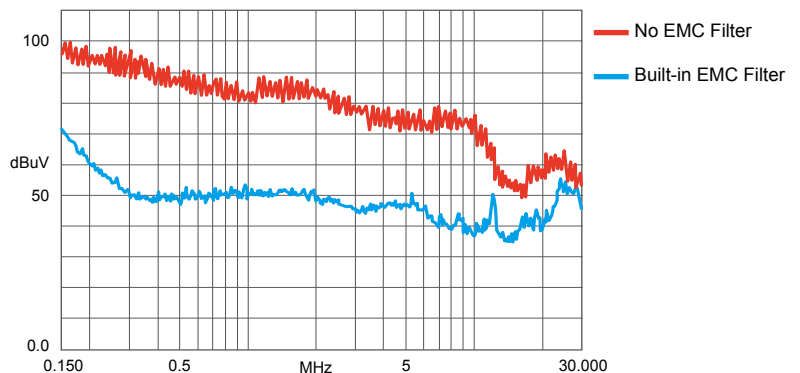

Easy to Install

Application Groups (Macro)

Simplifies the parameter setting process by grouping the parameters for different applications to use.

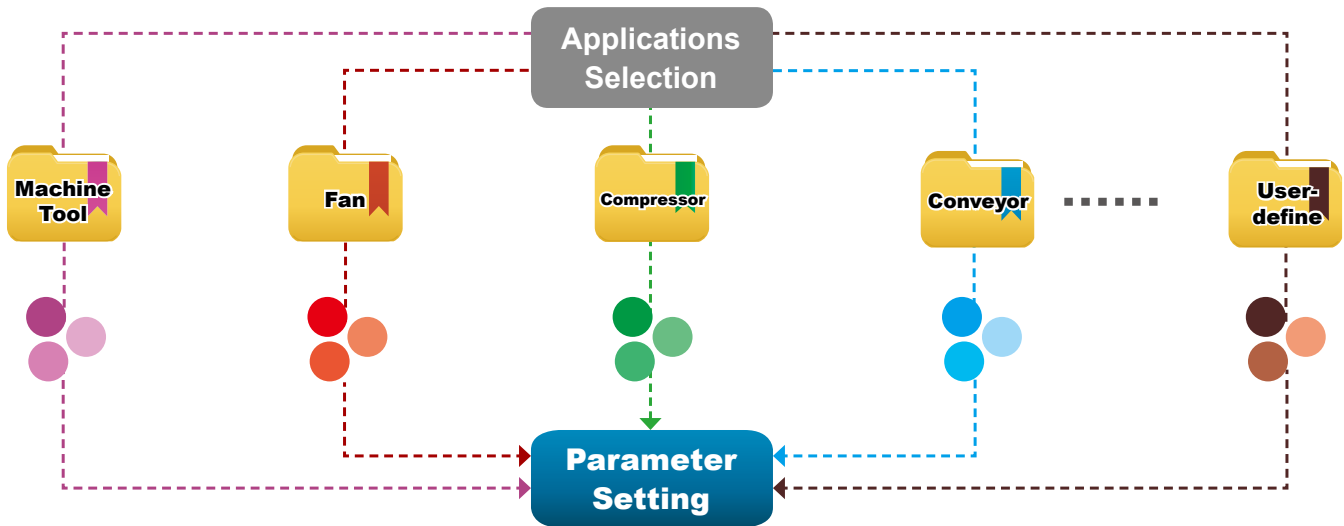

Built-in USB Port

Built-in USB port facilitates the drive setting, updating, real-time monitoring and system tuning process.

- No need of USB or RS-485 connectors
- Supports offline (drive power off) parameter setting/copying and system update

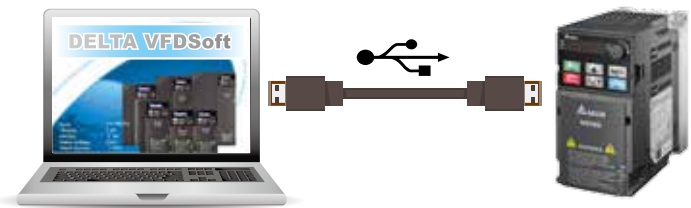

Screwless Wiring of Control Terminal

Spring clamp terminal blocks provide fast and easy wiring

Saves wiring time

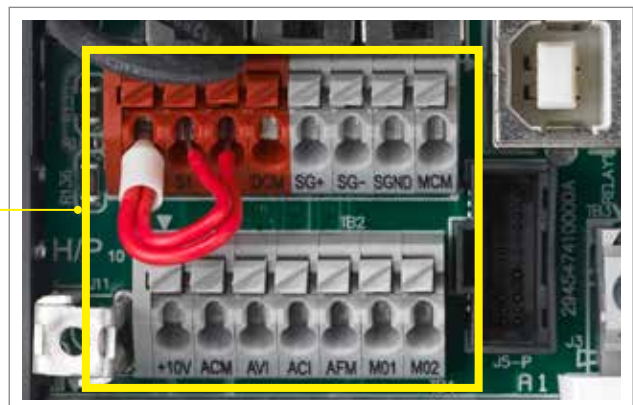

Wide Range of Applications



Machine Tools

Features and Benefits

- High-speed models support main spindle 1500Hz frequency output; and is suitable for complex and high precision processing applications
- Timely acceleration/deceleration control to improve machinery operation efficiency
- Built-in braking chopper to save on purchasing cost
- Built-in PLC capacity for flexible application needs
- Built-in STO function ensures operator safety and effectively reduces accident risk
- Provides deceleration to stop function to protect tools from damage and ensure operator safety

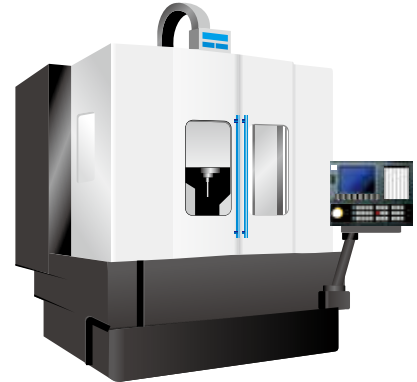

Woodworking Machines

Features and Benefits

- Timely acceleration/deceleration control, improves machinery operation efficiency
- Built-in STO function ensures operator safety and effectively reduces accident risk
- Built-in PLC capacity saves on purchasing cost
- Built-in EMC filter effectively reduces electromagnetic interference
- Compact in size and weight, easy to install and maintain

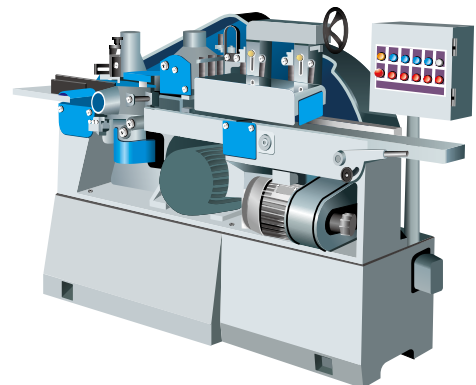

Automatic Tool Changers (ATC)

Features and Benefits

- Compact design of drive provides more cabinet space for other devices to use
- Quick start and timely acceleration/deceleration control function effectively shortens tool changing time and improves system efficiency and productivity
- Simple structure is easy to install and maintain
- Built-in STO function ensures operator safety and effectively reduces accident risk
- Built-in braking choppe saves on purchasing cost

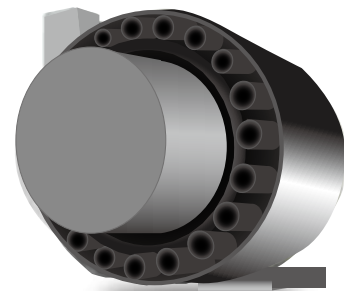

Pump Applications

Features and Benefits

- Built-in PID feedback control
- Built-in PLC capacity saves on purchasing cost of PLC and simpler wiring
- Supports a wide range of input voltages which are suitable for various types of pumps application and use in different countries
- Deceleration energy control mode shortens deceleration time and reduces braking resistor cost, also provides more space for other devices to use

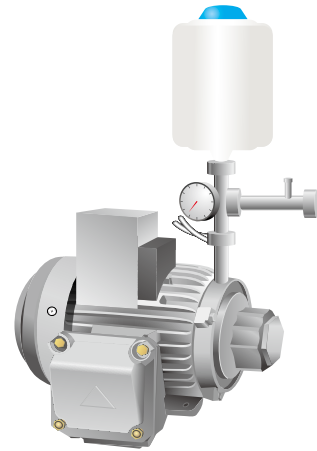

Packaging Machines

Features and Benefits

- Compact design of drive provides more cabinet space for other devices to use
- Built-in STO function ensures operator safety and effectively reduces accident rate
- Built-in braking chopper saves on system construction cost
- Built-in RS-485 (MODBUS) and various communication cards upon selection (optional)
- High-speed pulse input
- Supports frequency command by pulse input to improve control precision.



Textile Machines

Features and Benefits

- IP40 models provide excellent protection from a high dust, fiber or moisture environment
- Improved heatsink design prevents fiber clogging the air way; modular design of fan is easy to clean and provides longer lifetime
- Improved braking capability shortens the deceleration to stop time and is suitable for sudden stop requirements
- Built-in STO function ensures operator safety and effectively reduces accident rate
- Supports both induction motors and PM motors
- Provides deceleration to stop function to protect the equipment from damage when sudden power failure occurs



Specifications

Product Specifications

Single-phase
115V

Frame			Models without built-in EMC filter		
Frame			A		C
Applicable Motor Output (kW)			0.2	0.4	0.75
Applicable Motor Output (HP)			1/4	1/2	1
Inverter Output	Heavy Duty	Rated Output Current (A)	1.6	2.5	4.8
	Normal Duty	Rated Output Current (A)	1.8	2.7	5.5
Carrier Frequency (kHz)			2 ~ 15 (default 4)		
Brake Chopper			Built-in		
DC Reactor			Optional		
AC Reactor			Optional		
Cooling Method			Natural air cooling		Fan cooling
Size: W×H (mm)			68×128		87×157
Size: D (mm)			96	125	152

Single-phase
230V

Frame			Models with built-in EMC filter				
Frame			B		C		
Applicable Motor Output (kW)			0.2	0.4	0.75	1.5	2.2
Applicable Motor Output (HP)			1/4	1/2	1	2	3
Inverter Output	Heavy Duty	Rated Output Current (A)	1.6	2.8	4.8	7.5	11
	Normal Duty	Rated Output Current (A)	1.8	3.2	5	8.5	12.5
Carrier Frequency (kHz)			2 ~ 15 (default 4)				
Brake Chopper			Built-in				
DC Reactor			Optional				
AC Reactor			Optional				
Cooling Method			Natural air cooling	Fan cooling			
Size: W×H (mm)			72×142			87×157	
Size: D (mm)			159			179	
Frame			Models without an EMC filter				
Frame			A	B	C		
Cooling Method			Natural air cooling			Fan cooling	
Size: W×H (mm)			68×128	68×128	72×142	87×157	
Size: D (mm)			96	125	143	152	

3-phase
230 V

Models without built-in EMC filter

Frame			A			B	C		D	E		F
Applicable Motor Output (kW)			0.2	0.4	0.75	1.5	2.2	3.7/4	5.5	7.5	11	15
Applicable Motor Output (HP)			1/4	1/2	1	2	3	5	7.5	10	15	20
Inverter Output	Heavy Duty	Rated Output Current (A)	1.6	2.8	4.8	7.5	11	17	25	33	49	65
	Normal Duty	Rated Output Current (A)	1.8	3.2	5	8	12.5	19.5	27	36	51	69
Carrier Frequency (kHz)			2 ~ 15 (default 4)									
Brake Chopper			Built-in									
DC Reactor			Optional									
AC Reactor			Optional									
Cooling Method			Natural air cooling				Fan cooling					
Size: W×H (mm)			68×128			72×142	87×157	109×207	130×250	175×300		
Size: D (mm)			96	110	143	143	152	154	185	192		

3-phase
460 V

Models with built-in EMC filter

Frame			B			C		D		E		F	
Applicable Motor Output (kW)			0.4	0.75	1.5	2.2	3.7/4	5.5	7.5	11	15	18.5	22
Applicable Motor Output (HP)			1/2	1	2	3	5	7.5	10	15	20	25	30
Inverter Output	Heavy Duty	Rated Output Current (A)	1.5	2.7	4.2	5.5	9	13	17	25	32	38	45
	Normal Duty	Rated Output Current (A)	1.8	3	4.6	6.5	10.5	15.7	20.5	28	36	41.5	49
Carrier Frequency (kHz)			2 ~ 15 (default 4)										
Brake Chopper			Built-in										
DC Reactor			Optional										
AC Reactor			Optional										
Cooling Method			Fan cooling										
Size: W×H (mm)			72×142			87×157	109×207	130×250	175×300				
Size: D (mm)			159			179	187	219	244				
Models without an EMC filter													
Frame			A		B	C		D	E		F		
Cooling Method			Natural air cooling			Fan cooling							
Size: W×H (mm)			68×128		72×142	87×157	109×207	130×250	175×300				
Size: D (mm)			129	143	143	152	154	185	192				

General Specifications and Accessories

Control Functions	Control Methods	V/F, SVC
	Applicant Motors	Induction Motor (IM), Interior Permanent Magnet (IPM) Motor, Surface Permanent Magnet (SPM) Motor
	Max. Output Frequency	Standard model: 599.00Hz ; High speed model: 1500.0Hz (with derating, V/F control only)
	Starting Torque*	150%/3 Hz (V/f, SVC control for IM, heavy duty) 100%/(1/20 of motor rated frequency) (SVC control for PM, heavy duty)
	Speed Control Range*	1 : 50 (V/f, SVC control for IM, heavy duty) 1 : 20 (SVC control for PM, heavy duty)
	Overload Tolerance	Normal Duty (ND): 120% of rated output current for 60 seconds; 150% of rated output current for 3 seconds Heavy Duty (HD): 150% of rated output current for 60 seconds; 200% of rated output current for 3 seconds
	Frequency Setting Signal	0 ~ +10V/-10V ~ +10V, 4 ~ 20mA/0 ~ +10V, 1 pulse input (33kHz), 1 pulse output (33kHz)
	Main Control Functions	Multiple motor switches (max. 4 independent motor parameter settings), fast run, deceleration energy back (DEB) function, wobble frequency function, fast deceleration function, master and auxiliary frequency source selectable, momentary power loss ride thru, speed search, over-torque detection, 16-step speed (max.), accel/decel time switch, S-curve accel/decel, 3-wire sequence, JOG frequency, upper/lower limits for frequency reference, DC injection braking at start and stop, PID control, built-in PLC (2k steps), simple positioning function, MODBUS is integrated as standard
Protection Functions	Motor Protection	Overcurrent protection, overvoltage protection, over-temperature protection, phase failure protection
	Stall Prevention	Stall prevention during acceleration, deceleration and running independently
Accessories	Communication cards	PROFIBUS DP, DeviceNet, MODBUS TCP, EtherNet/IP, CANopen
	External DC power supply	EMM-BPS01 (DC 24V power supply card)
Digital Controller		A removable keypad as standard
Certifications		UL, CE, RoHS, RCM, TUV, REACH

*Control accuracy may vary depending on the environment, application conditions, different motors or encoder. For details, please contact our company or your local distributor.

MS300 Operating Environment

Operating Environment	Installation Location	IEC60364-1/IEC60664-1 Pollution degree 2, Indoor use only		
	Ambient Temperature (°C)	Operation	IP20/UL Open Type	-20 to 50 -20 to 60 (needs derating)
			IP40/NEMA 1/UL Type 1	-20 to 40
		Zero stacking Installation	-20 to 50 (needs derating)	
		Storage	-40 to 85	
	Rated Humidity	Transportation	-20 to 70	
		Operation	Max. 90%	
	Air Pressure (kPa)	Storage/Transportation	Max. 95%	
		Operation	86 ~ 106	
	Pollution Level	Storage/Transportation	70 ~ 106	
Altitude		Compliance to IEC60721-3-3, 3C2		
Altitude		An altitude of 0 ~ 1000m for normal operation (derating is required for installation at an altitude above 1000 m)		
Vibration		Compliance to IEC 60068-2-6		
Shock		Compliance to IEC/EN 60068-2-27		

Please refer to MS300 user manual for more details.

Wiring

Input: Single-phase/3-phase power

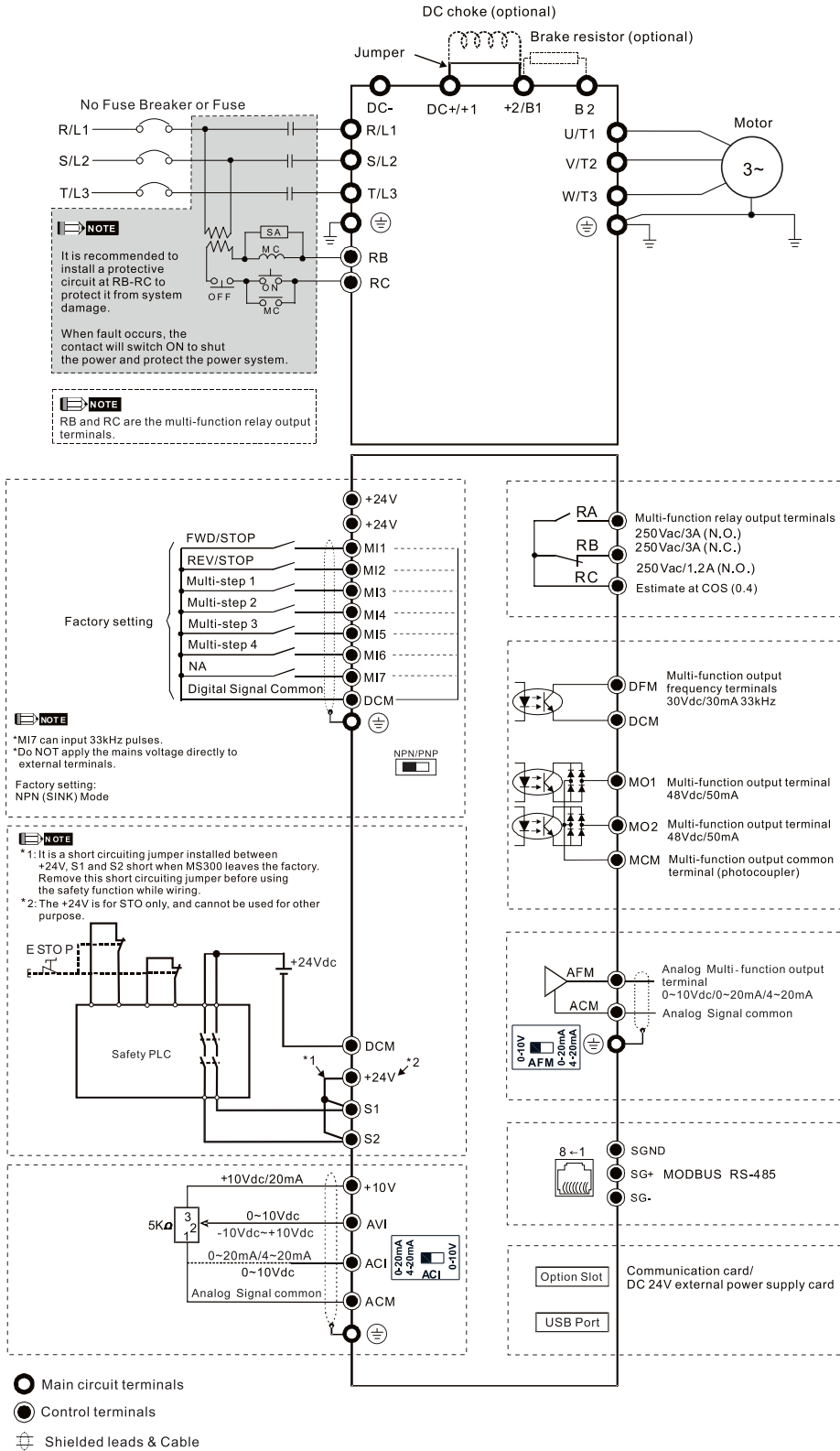

Dimensions

Frame A

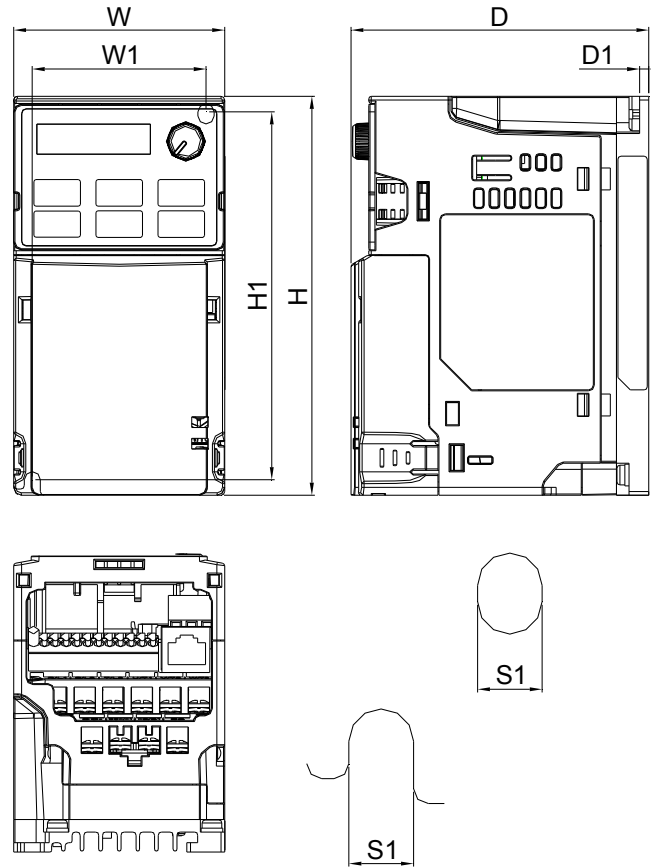

Mounting hole

MODEL	FRAME A1	FRAME A2	FRAME A3	FRAME A4	FRAME A5
VFD1A6MS11ANSAA	VFD2A8MS23ANSAA	VFD2A5MS11ANSAA	VFD1A5MS43ANSAA	VFD4A8MS23ANSAA	
VFD1A6MS11ENSAA	VFD2A8MS23ENSAA	VFD2A5MS11ENSAA	VFD1A5MS43ENSAA	VFD4A8MS23ENSAA	
VFD1A6MS21ANSAA		VFD2A8MS21ANSAA		VFD2A7MS43ANSAA	
VFD1A6MS21ENSAA		VFD2A8MS21ENSAA		VFD2A7MS43ENSAA	
VFD1A6MS23ANSAA					
VFD1A6MS23ENSAA					

Frame	W	H	D	W1	H1	D1	S1
A1	mm	68.0	128.0	96.0	56.0	118.0	3.0
	inch	2.68	5.04	3.78	2.20	4.65	0.12
A2	mm	68.0	128.0	110.0	56.0	118.0	3.0
	inch	2.68	5.04	4.33	2.20	4.65	0.12
A3	mm	68.0	128.0	125.0	56.0	118.0	3.0
	inch	2.68	5.04	4.92	2.20	4.65	0.12

Frame	W	H	D	W1	H1	D1	S1
A4	mm	68.0	128.0	129.0	56.0	118.0	3.0
	inch	2.68	5.04	5.08	2.20	4.65	0.12
A5	mm	68.0	128.0	143.0	56.0	118.0	3.0
	inch	2.68	5.04	5.63	2.20	4.65	0.12

Frame B

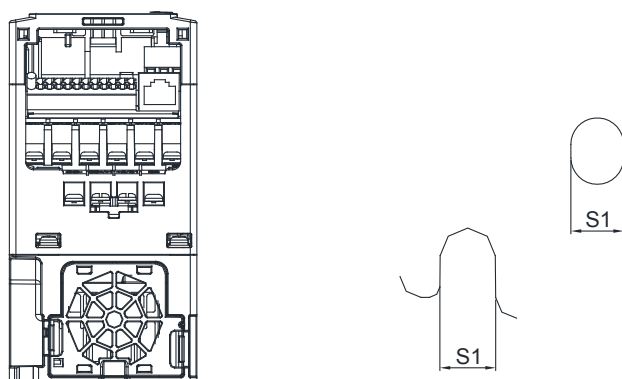
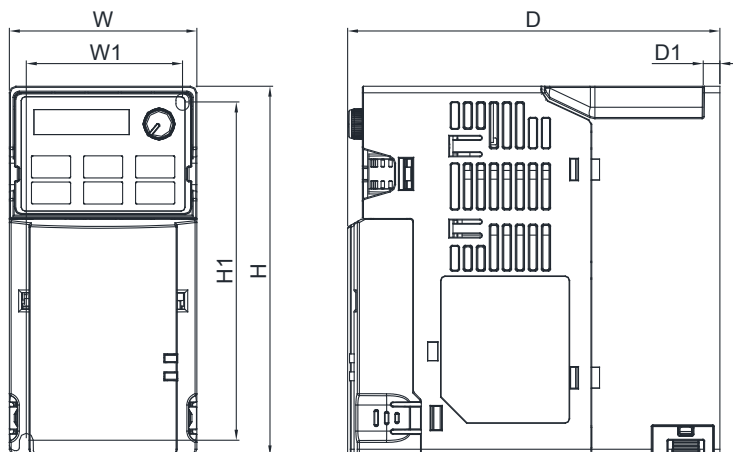

Mounting hole

MODEL FRAME B1

Standard Models:
 VFD7A5MS23ANSAA
 VFD7A5MS23ENSAA
 VFD4A2MS43ANSAA
 VFD4A2MS43ENSAA

High Speed Models:
 VFD7A5MS23ANSHA
 VFD7A5MS23ENSHA
 VFD4A2MS43ANSHA
 VFD4A2MS43ENSHA

FRAME B2

Standard Models:
 VFD4A8MS21ANSAA
 VFD4A8MS21ENSAA

FRAME B3

Standard Models:
 VFD1A6MS21AFSAA
 VFD2A8MS21AFSAA
 VFD4A8MS21AFSAA
 VFD1A5MS43AFSAA
 VFD2A7MS43AFSAA
 VFD4A2MS43AFSAA

High Speed Models:
 VFD4A2MS43AFSHA

Frame		W	H	D	W1	H1	D1	S1
B1	mm	72.0	142.0	143.0	60.0	130.0	6.4	5.2
	inch	2.83	5.59	5.63	2.36	5.12	0.25	0.20
Frame		W	H	D	W1	H1	D1	S1
B2	mm	72.0	142.0	143.0	60.0	130.0	3.0	5.2
	inch	2.83	5.59	5.63	2.36	5.12	0.12	0.20
Frame		W	H	D	W1	H1	D1	S1
B3	mm	72.0	142.0	159.0	60.0	130.0	4.3	5.2
	inch	2.83	5.59	6.26	2.36	5.12	0.17	0.20

Dimensions

Frame C

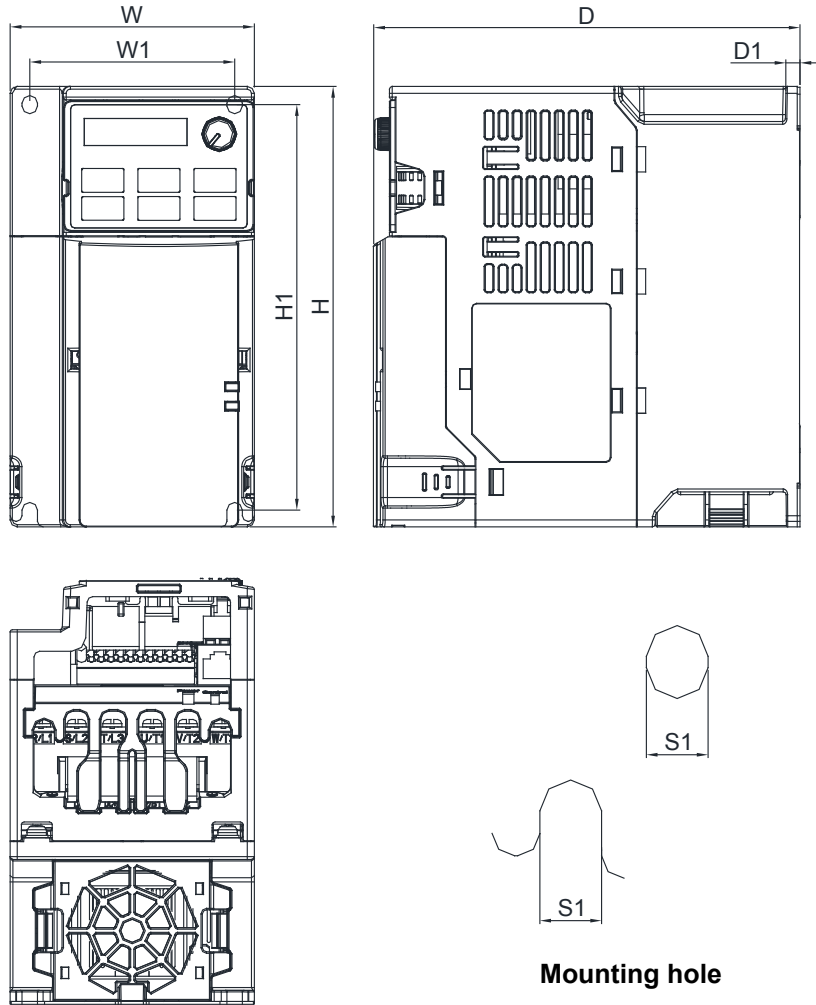

MODEL FRAME C1

Standard Models:

VFD4A8MS11ANSAA VFD4A8MS11ENSAA
 VFD7A5MS21ANSAA VFD7A5MS21ENSAA
 VFD11AMS21ANSAA VFD11AMS21ENSAA
 VFD11AMS23ANSAA VFD11AMS23ENSAA
 VFD17AMS23ANSAA VFD17AMS23ENSAA
 VFD5A5MS43ANSAA VFD5A5MS43ENSAA
 VFD9A0MS43ANSAA VFD9A0MS43ENSAA

High Speed Models:

VFD7A5MS21ANSHA VFD7A5MS21ENSHA
 VFD11AMS21ANSHA VFD11AMS21ENSHA
 VFD11AMS23ANSHA VFD11AMS23ENSHA
 VFD17AMS23ANSHA VFD17AMS23ENSHA
 VFD5A5MS43ANSHA VFD5A5MS43ENSHA
 VFD9A0MS43ANSHA VFD9A0MS43ENSHA

FRAME C2

Standard Models:

VFD7A5MS21AFSAA VFD7A5MS21AFSHA
 VFD11AMS21AFSAA VFD11AMS21AFSHA
 VFD5A5MS43AFSAA VFD5A5MS43AFSHA
 VFD9A0MS43AFSAA VFD9A0MS43AFSHA

High Speed Models:

VFD7A5MS21AFSHA VFD7A5MS21AFSHA
 VFD11AMS21AFSHA VFD11AMS21AFSHA
 VFD5A5MS43AFSHA VFD5A5MS43AFSHA
 VFD9A0MS43AFSHA VFD9A0MS43AFSHA

Frame		W	H	D	W1	H1	D1	S1
C1	mm	87.0	157.0	152.0	73.0	144.5	5.0	5.5
	inch	3.43	6.18	5.98	2.87	5.69	0.20	0.22
Frame		W	H	D	W1	H1	D1	S1
C2	mm	87.0	157.0	179.0	73.0	144.5	5.0	5.5
	inch	3.43	6.18	7.05	2.87	5.69	0.20	0.22

Frame D

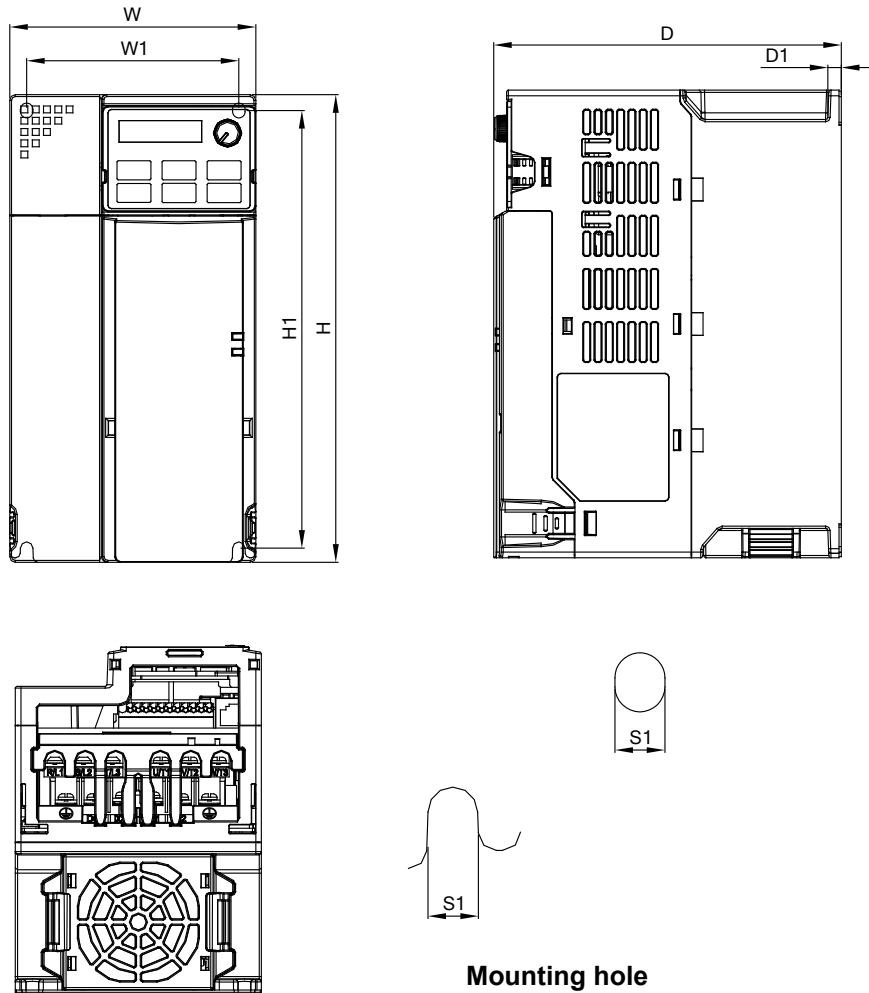

Mounting hole

MODEL FRAME D1

Standard Models:
 VFD25AMS23ANSAA
 VFD25AMS23ENSAA
 VFD13AMS43ANSAA
 VFD13AMS43ENSAA
 VFD17AMS43ANSAA
 VFD17AMS43ENSAA

High Speed Models:
 VFD25AMS23ANSHA
 VFD25AMS23ENSHA
 VFD13AMS43ANSHA
 VFD13AMS43ENSHA
 VFD17AMS43ANSHA
 VFD17AMS43ENSHA

FRAME D2

Standard Models:
 VFD13AMS43AFSAA
 VFD17AMS43AFSAA

High Speed Models:
 VFD13AMS43AFSHA
 VFD17AMS43AFSHA

Frame		W	H	D	W1	H1	D1	S1
D1	mm	109.0	207.0	154.0	94.0	193.8	6.0	5.5
	inch	4.29	8.15	6.06	3.70	7.63	0.24	0.22
Frame		W	H	D	W1	H1	D1	S1
D2	mm	109.0	207.0	187.0	94.0	193.8	6.0	5.5
	inch	4.29	8.15	7.36	3.70	7.63	0.24	0.22

Dimensions

Frame E

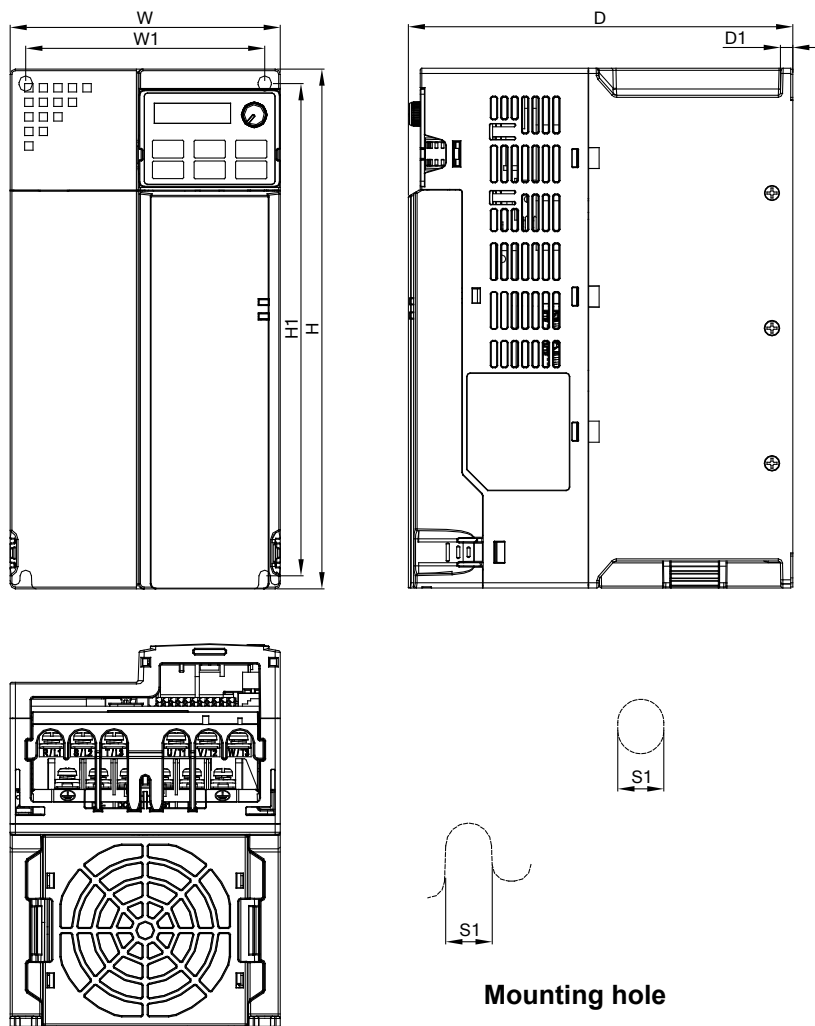

Mounting hole

MODEL FRAME E1

Standard Models:
 VFD33AMS23ANSAA
 VFD33AMS23ENSAA
 VFD49AMS23ANSAA
 VFD49AMS23ENSAA
 VFD25AMS43ANSAA
 VFD25AMS43ENSAA
 VFD32AMS43ANSAA
 VFD32AMS43ENSAA

High Speed Models:
 VFD33AMS23ANSHA
 VFD33AMS23ENSHA
 VFD49AMS23ANSHA
 VFD49AMS23ENSHA
 VFD25AMS43ANSHA
 VFD25AMS43ENSHA
 VFD32AMS43ANSHA
 VFD32AMS43ENSHA

FRAME E2

Standard Models:
 VFD25AMS43AFSAA
 VFD32AMS43AFSAA

High Speed Models:
 VFD25AMS43AFSHA
 VFD32AMS43AFSHA

Frame		W	H	D	W1	H1	D1	S1
E1	mm	130.0	250.0	185.0	115.0	236.8	6.0	5.5
	inch	5.12	9.84	7.83	4.53	9.32	0.24	0.22
Frame		W	H	D	W1	H1	D1	S1
E2	mm	130.0	250.0	219.0	115.0	236.8	6.0	5.5
	inch	5.12	9.84	8.62	4.53	9.32	0.24	0.22

Frame F

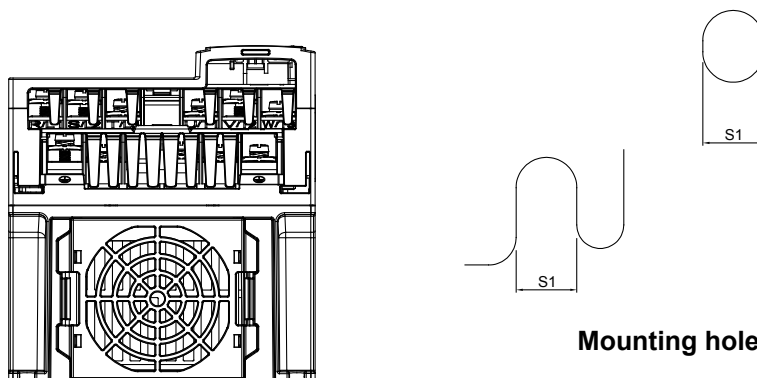
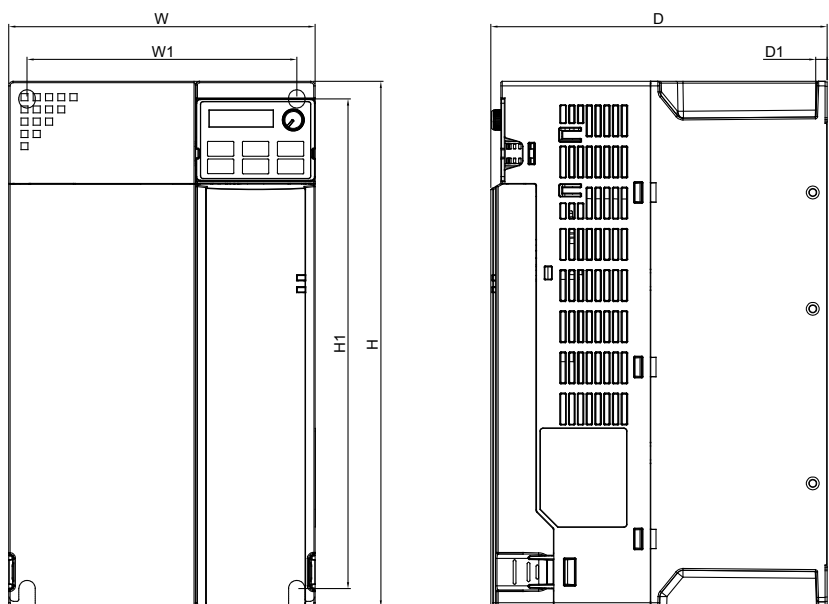

Mounting hole

MODEL FRAME F1

Standard Models:
 VFD65AMS23ANSAA
 VFD65AMS23ENSAA
 VFD38AMS43ANSAA
 VFD38AMS43ENSAA
 VFD45AMS43ANSAA
 VFD45AMS43ENSAA

High Speed Models:
 VFD65AMS23ANSHA
 VFD65AMS23ENSHA
 VFD38AMS43ANSHA
 VFD38AMS43ENSHA
 VFD45AMS43ANSHA
 VFD45AMS43ENSHA

FRAME F2

Standard Models:
 VFD38AMS43AFSAA
 VFD45AMS43AFSAA

High Speed Models:
 VFD38AMS43AFSHA
 VFD45AMS43AFSHA

Frame		W	H	D	W1	H1	D1	S1
F1	mm	175.0	300.0	192.0	154.0	279.5	6.5	8.4
	inch	6.89	11.81	7.56	6.06	11.00	0.26	0.33
Frame		W	H	D	W1	H1	D1	S1
F2	mm	175.0	300.0	244.0	154.0	279.5	6.5	8.4
	inch	6.89	11.81	9.61	6.06	11.00	0.26	0.33

Accessories

■ CMM-EIP01

EtherNet/IP Option Card



Features

- ▶ Supports max. 32 words input and 32 words output of I/O connection
- ▶ User-defined parameter mapping
- ▶ MDI/MDI-X auto-detect
- ▶ IP Filter, basic firewall function
- ▶ E-mail alarm

Network Interface

Network protocol	EtherNet/IP	Interface	RJ-45
Transmission speed	10/100Mbps	Number of port	1
Transmission method	I/O connection/Explicit message	Transmission cable	Category 5e shielding
Transmission distance	100m, extension is allowed via switch		

■ CMM-MOD01

MODBUS TCP Option Card



Features

- ▶ MDI/MDI-X auto-detect
- ▶ IP Filter, basic firewall function
- ▶ E-mail alarm

Network Interface

Network protocol	MODBUS TCP	Interface	RJ-45
Transmission speed	10/100Mbps	Number of port	1
Transmission distance	100 m, extension is allowed via switch	Transmission cable	Category 5e shielding

■ CMM-COP01

CANopen Option Card



Features

- ▶ Complies with CiA 402 standard (default setting)
- ▶ 4 sets of RX/TX PDO
- ▶ Dual communication ports
- ▶ Node address and Baud rate can be set in the AC motor drive
- ▶ Supports Delta protocol, DMCNET

Network Interface

Network protocol	CANopen	Interface	RJ-45
Transmission speed	1Mbps/ 500Kbps/ 250Kbps/ 125Kbps/ 100Kbps/ 50Kbps	Number of port	2
Transmission method	PDO, SDO	Transmission cable	Delta standard
Transmission distance	25m/1Mbps		

■ CMM-DN01

DeviceNet Option Card



Features

- ▶ Support Group 2 only connection method and cyclic I/O data exchange
- ▶ Provides EDS file to identify DeviceNet equipment information
- ▶ Supports max. 32 words input and 32 words output of parameter mapping
- ▶ Node address and Baud rate can be set in the AC motor drive

Network Interface

Network protocol	DeviceNet	Interface	Terminal block
Transmission speed	500Kbps/ 250Kbps/ 125Kbps/ 100Kbps/ 50Kbps and extendable baud rate mode of 1M	Number of port	1
Transmission method	Explicit message/Implicit message	Transmission cable	Delta standard
Transmission distance	25m/1Mbps		

■ CMM-PD01

PROFIBUS DP Option Card



Features

- ▶ Supports PZD cyclic data exchange
- ▶ Supports user diagnosis function.
- ▶ Supports PKW read/write to AC motor drive parameters
- ▶ Auto-detects baud rates; supports Max. 12 Mbps.

Network Interface

Network protocol	PROFIBUS DP	Interface	DB9
Transmission speed	9.6 Kbps/ 19.2 Kbps/ 93.75 Kbps/ 187.5 Kbps/ 500 Kbps/ 1.5 Mbps/ 3 Mbps/ 6 Mbps/ 12 Mbps	Number of port	1
Transmission method	Cyclic / non-cyclic data exchange	Transmission cable	Delta standard
Transmission distance	100m / 12Mbps		

■ EMM-BPS01

24V Power Shift Card



Terminals	Description
PE GND 24V	<p>When the AC motor drive power is off, the external power supply card provides external power to the network system, PLC function, and other functions to allow continued operations. Input power: 24 V ± 5% Maximum input current: 0.5A</p> <p>Note: 1) Do not connect the control terminal +24V (Digital control signal common: SOURCE) directly to the EMC-BPS01 input terminal 24V. 2) Do not connect control terminal GND directly to the EMC-BPS01 input terminal GND in order to achieve good isolation.</p>

Note 1: For the Open Collector, set input voltage to 5 ~ 15mA and install a pull-up resistor

[5V] Recommend pull-up resistor: 100 ~ 220Ω, 1 / 2W and above

[12V] Recommend pull-up resistor: 510 ~ 1.35KΩ, 1 / 2W and above

[24V] Recommend pull-up resistor: 1.8K ~ 3.3KΩ, 1 / 2W and above

■ Screw Specification of Option Card Terminals

Screw Specification of Option Card Terminals	Wire Gauge	Torque
CMM-COP01	30 ~ 16 AWG (0.0509 ~ 1.31 mm ²)	2 Kg-cm [1.74 lb-in]
CMM-MOD01/CMM-EIP01		
CMM-PD01		
CMM-DN01		
EMM-BPS01		
	30 ~ 16 AWG (0.0509 ~ 1.31 mm ²)	8 Kg-cm [6.94 lb-in]

■ Delta Standard Fieldbus Cables

Delta Cables	Part Number	Description	Length
CANopen Cable	UC-CMC003-01A	CANopen cable, RJ45 connector	0.3m
	UC-CMC005-01A	CANopen cable, RJ45 connector	0.5m
	UC-CMC010-01A	CANopen cable, RJ45 connector	1m
	UC-CMC015-01A	CANopen cable, RJ45 connector	1.5m
	UC-CMC020-01A	CANopen cable, RJ45 connector	2m
	UC-CMC030-01A	CANopen cable, RJ45 connector	3m
	UC-CMC050-01A	CANopen cable, RJ45 connector	5m
	UC-CMC100-01A	CANopen cable, RJ45 connector	10m
	UC-CMC200-01A	CANopen cable, RJ45 connector	20m
DeviceNet Cable	UC-DN01Z-01A	DeviceNet cable	305m
	UC-DN01Z-02A	DeviceNet cable	305m
EtherNet/EtherCAT Cable	UC-EMC003-02A	EtherNet/EtherCAT cable, Shielding	0.3m
	UC-EMC005-02A	EtherNet/EtherCAT cable, Shielding	0.5m
	UC-EMC010-02A	EtherNet/EtherCAT cable, Shielding	1m
	UC-EMC020-02A	EtherNet/EtherCAT cable, Shielding	2m
	UC-EMC050-02A	EtherNet/EtherCAT cable, Shielding	5m
	UC-EMC100-02A	EtherNet/EtherCAT cable, Shielding	10m
CANopen/DeviceNet TAP	UC-EMC200-02A	EtherNet/EtherCAT cable, Shielding	20m
	TAP-CN01	1 in 2 out, built-in 121Ω terminal resistor	1 in 2 out
	TAP-CN02	1 in 4 out, built-in 121Ω terminal resistor	1 in 4 out
PROFIBUS Cable	TAP-CN03	1 in 4 out, RJ45 connector, built-in 121Ω terminal resistor	1 in 4 out
	UC-PF01Z-01A	PROFIBUS DP cable	305m

Extension Cable for Digital Keypad

MS300 Extension Cable

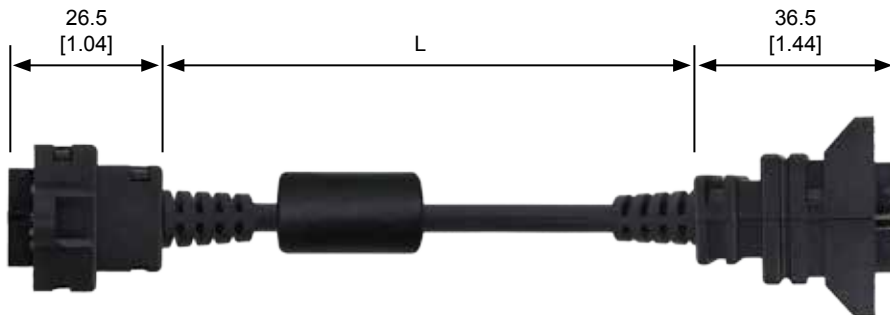

Part No.	L	
	mm	[inch]
EG0610C	600	23.6
EG1010C	1000	39.4
EG2010C	2000	78.7
EG3010C	3000	118.1
EG5010C	5000	196.8

Model Name Explanation

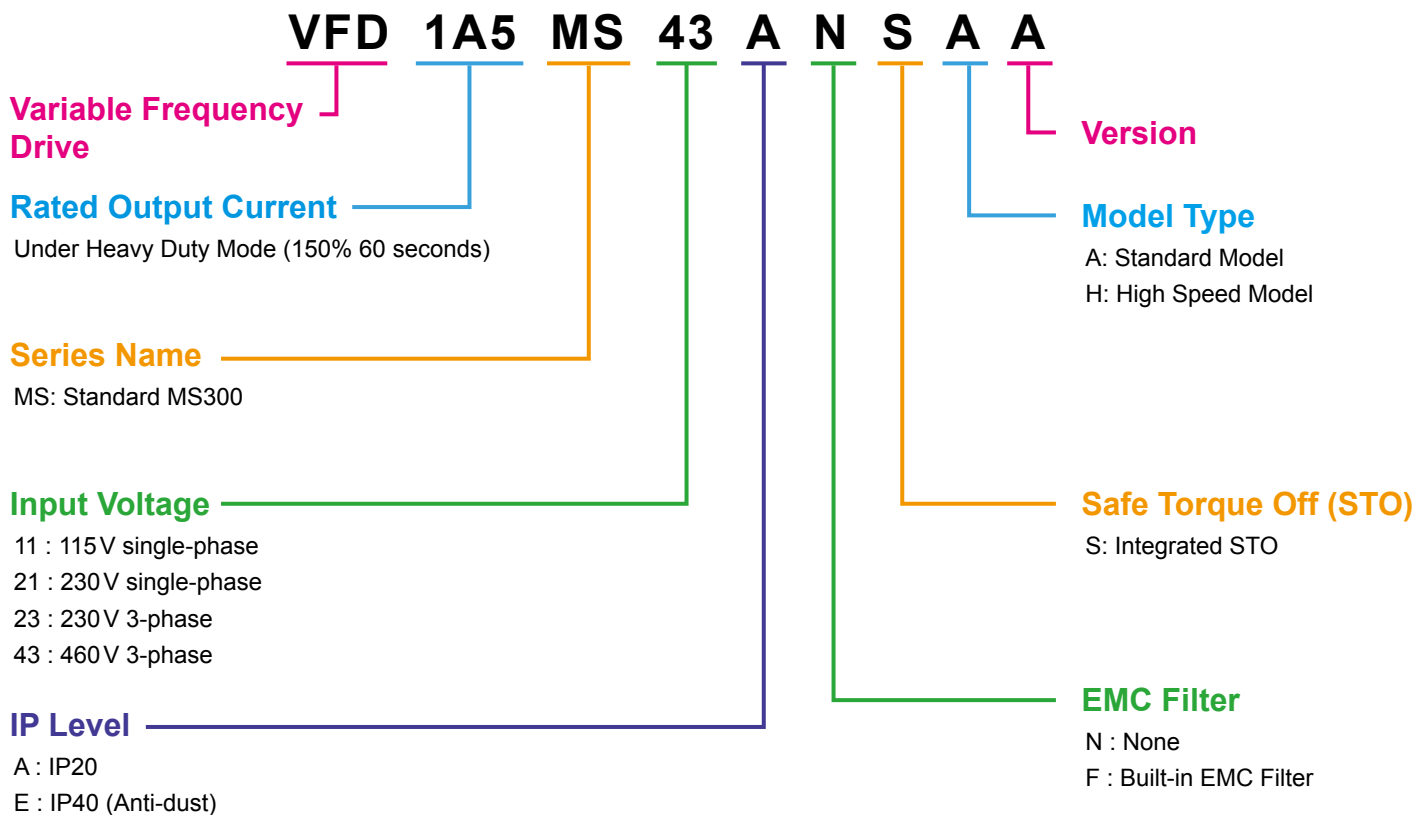

Ordering Information

MS300 Standard Models (0 ~ 599 Hz)

Power Range			Frame Size	Model Name	Standard Models (0 ~ 599 Hz)	
Max. Applicable Motor Capacity		Drive Rated Output Current			Built-in EMC Filter	IP40 Models
[HP]	[kW]	[A]				
115V/single-phase						
0.25	0.2	1.6	A	VFD1A6MS11ANSAA	-	-
				VFD1A6MS11ENSAA	-	V
0.5	0.4	2.5	A	VFD2A5MS11ANSAA	-	-
				VFD2A5MS11ENSAA	-	V
1	0.75	4.8	C	VFD4A8MS11ANSAA	-	-
				VFD4A8MS11ENSAA	-	V
230V/single-phase						
1/4	0.2	1.6	A	VFD1A6MS21ANSAA	-	-
			A	VFD1A6MS21ENSAA	-	V
			B	VFD1A6MS21AFSAA	V	-
0.5	0.4	2.8	A	VFD2A8MS21ANSAA	-	-
			A	VFD2A8MS21ENSAA	-	V
			B	VFD2A8MS21AFSAA	V	-
1	0.75	4.8	B	VFD4A8MS21ANSAA	-	-
				VFD4A8MS21AFSAA	V	-
				VFD4A8MS21ENSAA	-	V
2	1.5	7.5	C	VFD7A5MS21ANSAA	-	-
				VFD7A5MS21AFSAA	V	-
				VFD7A5MS21ENSAA	-	V
3	2.2	11.0	C	VFD11AMS21ANSAA	-	-
				VFD11AMS21AFSAA	V	-
				VFD11AMS21ENSAA	-	V
230V/3-phase						
0.25	0.2	1.6	A	VFD1A6MS23ANSAA	-	-
				VFD1A6MS23ENSAA	-	V
0.5	0.4	2.8	A	VFD2A8MS23ANSAA	-	-
				VFD2A8MS23ENSAA	-	V
1	0.75	4.8	A	VFD4A8MS23ANSAA	-	-
				VFD4A8MS23ENSAA	-	V
2	1.5	7.5	B	VFD7A5MS23ANSAA	-	-
				VFD7A5MS23ENSAA	-	V
3	2.2	11.0	C	VFD11AMS23ANSAA	-	-
				VFD11AMS23ENSAA	-	V
5	3.7/4	17.0	C	VFD17AMS23ANSAA	-	-
				VFD17AMS23ENSAA	-	V
7.5	5.5	25.0	D	VFD25AMS23ANSAA	-	-
				VFD25AMS23ENSAA	-	V
10	7.5	33.0	E	VFD33AMS23ANSAA	-	-
				VFD33AMS23ENSAA	-	V
15	11	49.0	E	VFD49AMS23ANSAA	-	-
				VFD49AMS23ENSAA	-	V
20	15	65.0	F	VFD65AMS23ANSAA	-	-
				VFD65AMS23ENSAA	-	V

Ordering Information

MS300 Standard Models (0 ~ 599 Hz)

Power Range			Frame Size	Model Name	Standard Models (0 ~ 599 Hz)	
Max. Applicable Motor Capacity		Drive Rated Output Current			Built-in EMC Filter	IP40 Models
[HP]	[kW]	[A]				
460 V/3-phase						
0.5	0.4	1.5	A	VFD1A5MS43ANSAA	-	-
			A	VFD1A5MS43ENSAA	-	V
			B	VFD1A5MS43AFSAA	V	-
1	0.75	2.7	A	VFD2A7MS43ANSAA	-	-
			A	VFD2A7MS43ENSAA	-	V
			B	VFD2A7MS43AFSAA	V	-
2	1.5	4.2	B	VFD4A2MS43ANSAA	-	-
				VFD4A2MS43ENSAA	-	V
				VFD4A2MS43AFSAA	V	-
3	2.2	5.5	C	VFD5A5MS43ANSAA	-	-
				VFD5A5MS43ENSAA	-	V
				VFD5A5MS43AFSAA	V	-
5	3.7/4	9.0	C	VFD9A0MS43ANSAA	-	-
				VFD9A0MS43ENSAA	-	V
				VFD9A0MS43AFSAA	V	-
7.5	5.5	13.0	D	VFD13AMS43ANSAA	-	-
				VFD13AMS43ENSAA	-	V
				VFD13AMS43AFSAA	V	-
10	7.5	17.0	D	VFD17AMS43ANSAA	-	-
				VFD17AMS43ENSAA	-	V
				VFD17AMS43AFSAA	V	-
15	11	25.0	E	VFD25AMS43ANSAA	-	-
				VFD25AMS43ENSAA	-	V
				VFD25AMS43AFSAA	V	-
20	15	32.0	E	VFD32AMS43ANSAA	-	-
				VFD32AMS43ENSAA	-	V
				VFD32AMS43AFSAA	V	-
25	18.5	38.0	F	VFD38AMS43ANSAA	-	-
				VFD38AMS43ENSAA	-	V
				VFD38AMS43AFSAA	V	-
30	22	45.0	F	VFD45AMS43ANSAA	-	-
				VFD45AMS43ENSAA	-	V
				VFD45AMS43AFSAA	V	-

MS300 High Speed Models (0 ~ 1500 Hz)

Power Range			Frame Size	Model Name	High Speed Models (0 ~ 1500Hz)	
Max. Applicable Motor Capacity		Drive Rated Output Current			Built-in EMC Filter	IP40 Models
[HP]	[kW]	[A]				
230V/single-phase						
2	1.5	7.5	C	VFD7A5MS21ANSHA	-	-
				VFD7A5MS21ENSHA	-	V
				VFD7A5MS21AFSHA	V	-
3	2.2	11.0	C	VFD11AMS21ANSHA	-	-
				VFD11AMS21ENSHA	-	V
				VFD11AMS21AFSHA	V	-
230V/3-phase						
2	1.5	7.5	B	VFD7A5MS23ANSHA	-	-
				VFD7A5MS23ENSHA	-	V
3	2.2	11.0	C	VFD11AMS23ANSHA	-	-
				VFD11AMS23ENSHA	-	V
5	3.7/4	17.0	C	VFD17AMS23ANSHA	-	-
				VFD17AMS23ENSHA	-	V
7.5	5.5	25.0	D	VFD25AMS23ANSHA	-	-
				VFD25AMS23ENSHA	-	V
10	7.5	33.0	E	VFD33AMS23ANSHA	-	-
				VFD33AMS23ENSHA	-	V
15	11	49.0	E	VFD49AMS23ANSHA	-	-
				VFD49AMS23ENSHA	-	V
20	15	65.0	F	VFD65AMS23ANSHA	-	-
				VFD65AMS23ENSHA	-	V
460V/3-phase						
2	1.5	4.2	B	VFD4A2MS43ANSHA	-	-
				VFD4A2MS43ENSHA	-	V
				VFD4A2MS43AFSHA	V	-
3	2.2	5.5	C	VFD5A5MS43ANSHA	-	-
				VFD5A5MS43ENSHA	-	V
				VFD5A5MS43AFSHA	V	-
5	3.7/4	9.0	C	VFD9A0MS43ANSHA	-	-
				VFD9A0MS43ENSHA	-	V
				VFD9A0MS43AFSHA	V	-
7.5	5.5	13.0	D	VFD13AMS43ANSHA	-	-
				VFD13AMS43ENSHA	-	V
				VFD13AMS43AFSHA	V	-
10	7.5	17.0	D	VFD17AMS43ANSHA	-	-
				VFD17AMS43ENSHA	-	V
				VFD17AMS43AFSHA	V	-
15	11	25.0	E	VFD25AMS43ANSHA	-	-
				VFD25AMS43ENSHA	-	V
				VFD25AMS43AFSHA	V	-
20	15	32.0	E	VFD32AMS43ANSHA	-	-
				VFD32AMS43ENSHA	-	V
				VFD32AMS43AFSHA	V	-
25	18.5	38.0	F	VFD38AMS43ANSHA	-	-
				VFD38AMS43ENSHA	-	V
				VFD38AMS43AFSHA	V	-
30	22	45.0	F	VFD45AMS43ANSHA	-	-
				VFD45AMS43ENSHA	-	V
				VFD45AMS43AFSHA	V	-



Smarter. Greener. Together.

Industrial Automation Headquarters

Delta Electronics, Inc.

Taoyuan Technology Center
No.18, Xinglong Rd., Taoyuan District,
Taoyuan City 33068, Taiwan
TEL: 886-3-362-6301 / FAX: 886-3-371-6301

Asia

Delta Electronics (Shanghai) Co., Ltd.

No.182 Minyu Rd., Pudong Shanghai, P.R.C.
Post code : 201209
TEL: 86-21-6872-3988 / FAX: 86-21-6872-3996
Customer Service: 400-820-9595

Delta Electronics (Japan), Inc.

Tokyo Office
Industrial Automation Sales Department
2-1-14 Shibadaimon, Minato-ku
Tokyo, Japan 105-0012
TEL: 81-3-5733-1155 / FAX: 81-3-5733-1255

Delta Electronics (Korea), Inc.

Seoul Office
1511, 219, Gasan Digital 1-Ro., Geumcheon-gu,
Seoul, 08501 South Korea
TEL: 82-2-515-5305 / FAX: 82-2-515-5302

Delta Energy Systems (Singapore) Pte Ltd.

4 Kaki Bukit Avenue 1, #05-04, Singapore 417939
TEL: 65-6747-5155 / FAX: 65-6744-9228

Delta Electronics (India) Pvt. Ltd.

Plot No.43, Sector 35, HSIIDC Gurgaon,
PIN 122001, Haryana, India
TEL: 91-124-4874900 / FAX : 91-124-4874945

Delta Electronics (Thailand) PCL.

909 Soi 9, Moo 4, Bangpoo Industrial Estate (E.P.Z),
Pattana 1 Rd., T.Phraksa, A.Muang,
Samutprakarn 10280, Thailand
TEL: 66-2709-2800 / FAX : 662-709-2827

Delta Energy Systems (Australia) Pty Ltd.

Unit 20-21/45 Normanby Rd., Nottling Hill Vic 3168, Australia
TEL: 61-3-9543-3720

Americas

Delta Electronics (Americas) Ltd.

Raleigh Office
P.O. Box 12173, 5101 Davis Drive,
Research Triangle Park, NC 27709, U.S.A.
TEL: 1-919-767-3813 / FAX: 1-919-767-3969

Delta Greentech (Brasil) S/A

São Paulo Office
Rua Itapeva, 26 – 3° Andar - Bela Vista
CEP: 01332-000 – São Paulo – SP - Brasil
TEL: 55-11-3530-8642 / 55-11-3530-8640

Delta Electronics International Mexico S.A. de C.V.

Mexico Office
Vía Dr. Gustavo Baz No. 2160, Colonia La Loma,
54060 Tlalnepantla Estado de Mexico
TEL: 52-55-2628-3015 #3050/3052

EMEA

Delta Electronics (Netherlands) BV

Eindhoven Office
De Witbogt 20, 5652 AG Eindhoven, The Netherlands
MAIL: Sales.IA.EMEA@deltaww.com
MAIL: Sales.IA.Benelux@deltaww.com

Delta Electronics (France) S.A.

ZI du bois Chaland 2 15 rue des Pyrénées,
Lisses 91056 Evry Cedex, France
MAIL: Sales.IA.FR@deltaww.com

Delta Electronics Solutions (Spain) S.L.U

Ctra. De Villaverde a Vallecas, 265 1° Dcha Ed.
Hormigueras – P.I. de Vallecas 28031 Madrid
C/Llull, 321-329 (Edificio CINC) | 22@Barcelona, 08019 Barcelona
MAIL: Sales.IA.Iberia@deltaww.com

Delta Electronics (Italy) Srl

Ufficio di Milano Via Senigallia 18/2 20161 Milano (MI)
Piazza Grazioli 18 00186 Roma, Italy
MAIL: Sales.IA.Italy@deltaww.com

Delta Electronics (Germany) GmbH

Coesterweg 45, D-59494 Soest, Germany
MAIL: Sales.IA.DACH@deltaww.com

Delta Energy Systems LLC (CIS)

Vereyskaya Plaza II, office 112 Vereyskaya str.
17 121357 Moscow, Russia
MAIL: Sales.IA.RU@deltaww.com

Delta Greentech Ltd. (Turkiye)

Serifali Mevkii Barbaros Bulvari Soylesi Sok
No 19 34775, Y.Dudullu-Umraniye/Istanbul
MAIL: Sales.IA.Turkey@delta-emea.com

Delta Energy Systems AG (Dubai BR)

P.O. Box 185668, Gate 7, 3rd Floor, Hamarain Centre,
Dubai, United Arab Emirates
MAIL: Sales.IA.MEA@deltaww.com